



A strong, smart, inclusive and sustainable community



.....
Limes Farm/Copperfield Estate for Baily Garner
Vision Board
.....

Thank you!

Thank you for the opportunity to propose an outdoor gym for Limes Farm Copperfield Estate.

We have a vision of helping people lead healthy, happy lives. Movement and nature boost our physical and mental wellbeing. Our workout spaces bring people together, connecting people in a positive way.

We can also train activators to run group workout sessions so that people feel part of a community. We are excited by your space and how this project will regenerate it to become a great asset for the community.





About TGO

We are a family business and have installed over 1800 outdoor gyms.

We have worked with some amazing customers over the years including Rolls Royce, United Nations, adidas and hundreds of councils and schools. We make our gyms 100% in the UK and we are globally seen as leaders in design, standards and safety. We not only meet the EU standards for outdoor gyms we beat them by going above and beyond. We designed our gyms like a playground removing crush points, entrapments and sharp edges, making the experience very safe.

We are always pushing the boundaries. We have gym equipment that generates power from human energy, we have screens that can provide workouts and a range of equipment that includes all ages and abilities.

Render in Situ Limes Farm/Copperfield Estate - Option One

.....



Render in Situ Limes Farm/Copperfield Estate - Option Two

.....



Render in Situ Limes Farm/Copperfield Estate - Option Three

.....



Render in Situ Limes Farm/Copperfield Estate - Option Four

.....



Gym Equipment Limes Farm/Copperfield Estate - Option One

Equipment List:

1. Power Smart Hand Bike
2. Power Smart Spinning Bike
3. Cross Trainer
4. Recumbent Bike
5. Double Leg Press
6. Sit Up Bench
7. Chest Press/Seated Row
8. Lat Pull Down/Shoulder Press
9. Parallel Bars
10. Pull Up/Assisted Pull Up
11. Triple Pull Up Bar

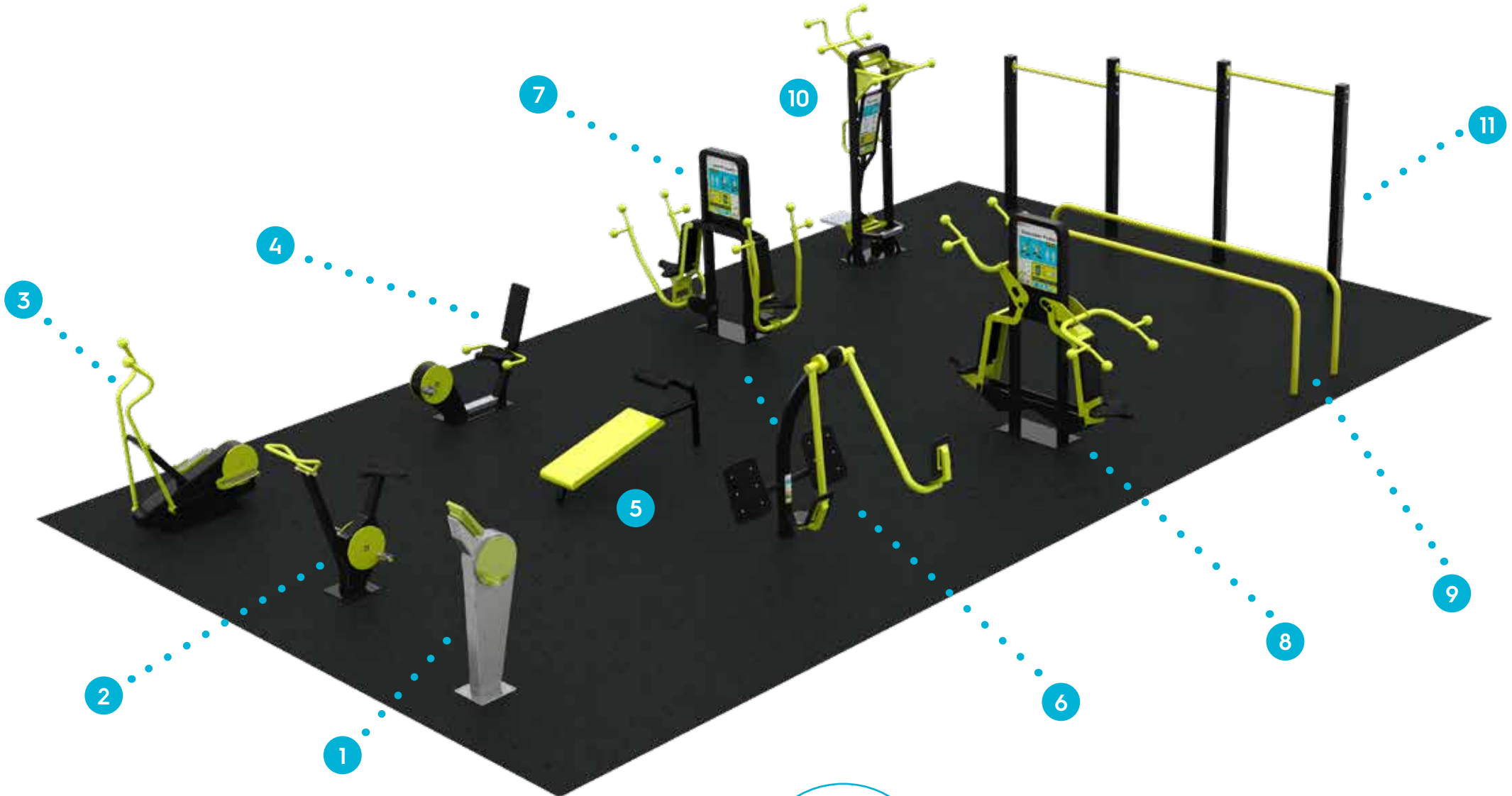

Gym Equipment Limes Farm/Copperfield Estate - Option Two

Equipment List:

1. Power Smart Hand Bike
2. Power Smart Spinning Bike
3. Cross Trainer
4. Recumbent Bike
5. Double Leg Press
6. Sit Up Bench
7. Chest Press/Seated Row
8. Lat Pull Down/Shoulder Press
9. Parallel Bars
10. Pull Up/Assisted Pull Up
11. Triple Pull Up Bar

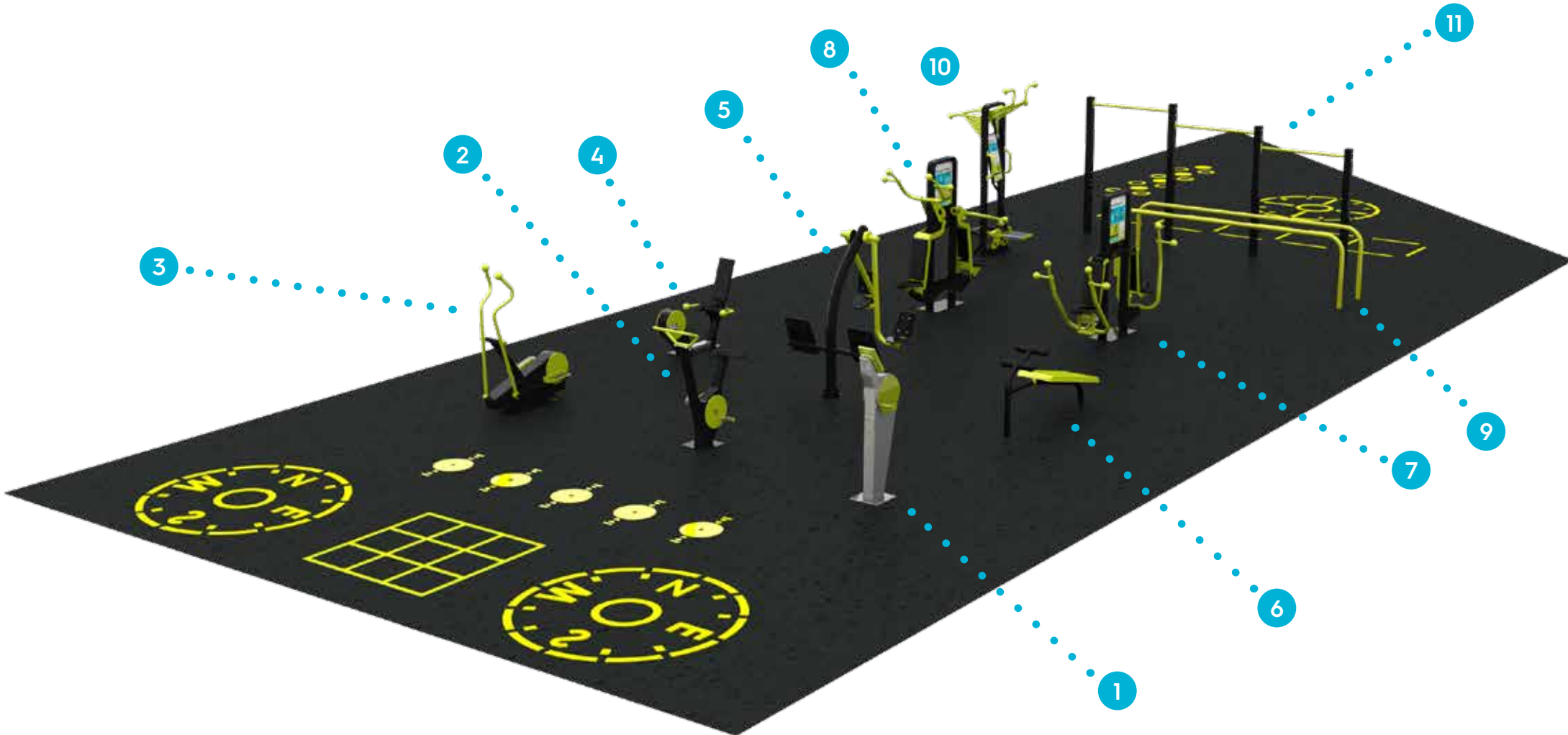

Gym Equipment Limes Farm/Copperfield Estate - Option Three

Equipment List:

- | | | | |
|------------------------------|---------------------|---------------------------------|------------------------------|
| 1. Power Smart Hand Bike | 4. Recumbent Bike | 7. Chest Press/Seated Row | 10. Pull Up/Assisted Pull Up |
| 2. Power Smart Spinning Bike | 5. Double Leg Press | 8. Lat Pull Down/Shoulder Press | 11. Triple Pull Up Bar |
| 3. Cross Trainer | 6. Sit Up Bench | 9. Parallel Bars | 12. Calisthenics Rig |

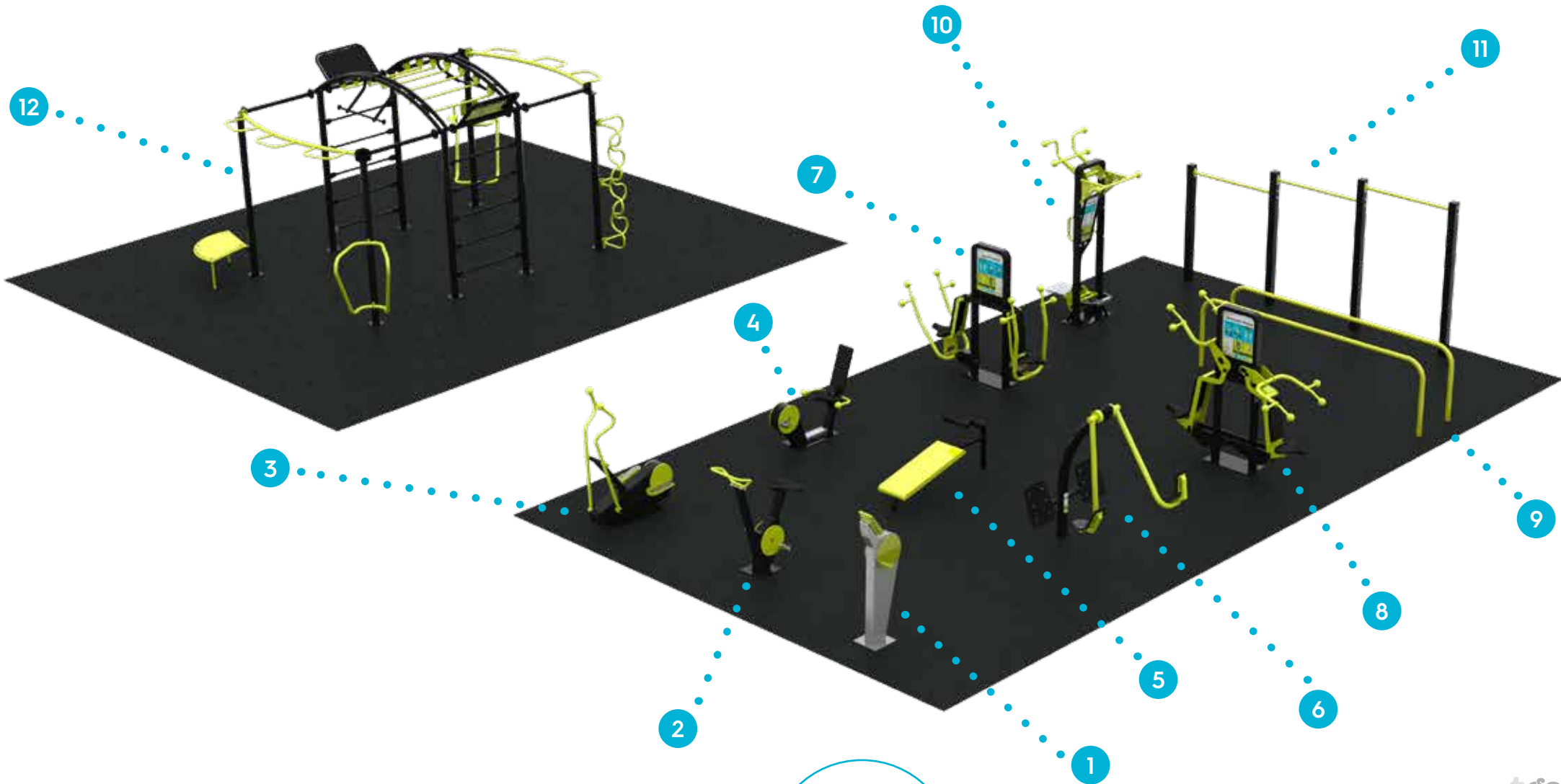

Gym Equipment Limes Farm/Copperfield Estate - Option Four

Equipment List:

- 1. Power Smart Hand Bike
- 2. Power Smart Spinning Bike
- 3. Cross Trainer
- 4. Recumbent Bike
- 5. Double Leg Press
- 6. Sit Up Bench
- 7. Chest Press/Seated Row
- 8. Lat Pull Down/Shoulder Press
- 9. Parallel Bars
- 10. Pull Up/Assisted Pull Up
- 11. Triple Pull Up Bar
- 12. Calisthenics Rig
- 13. Active Line Markings

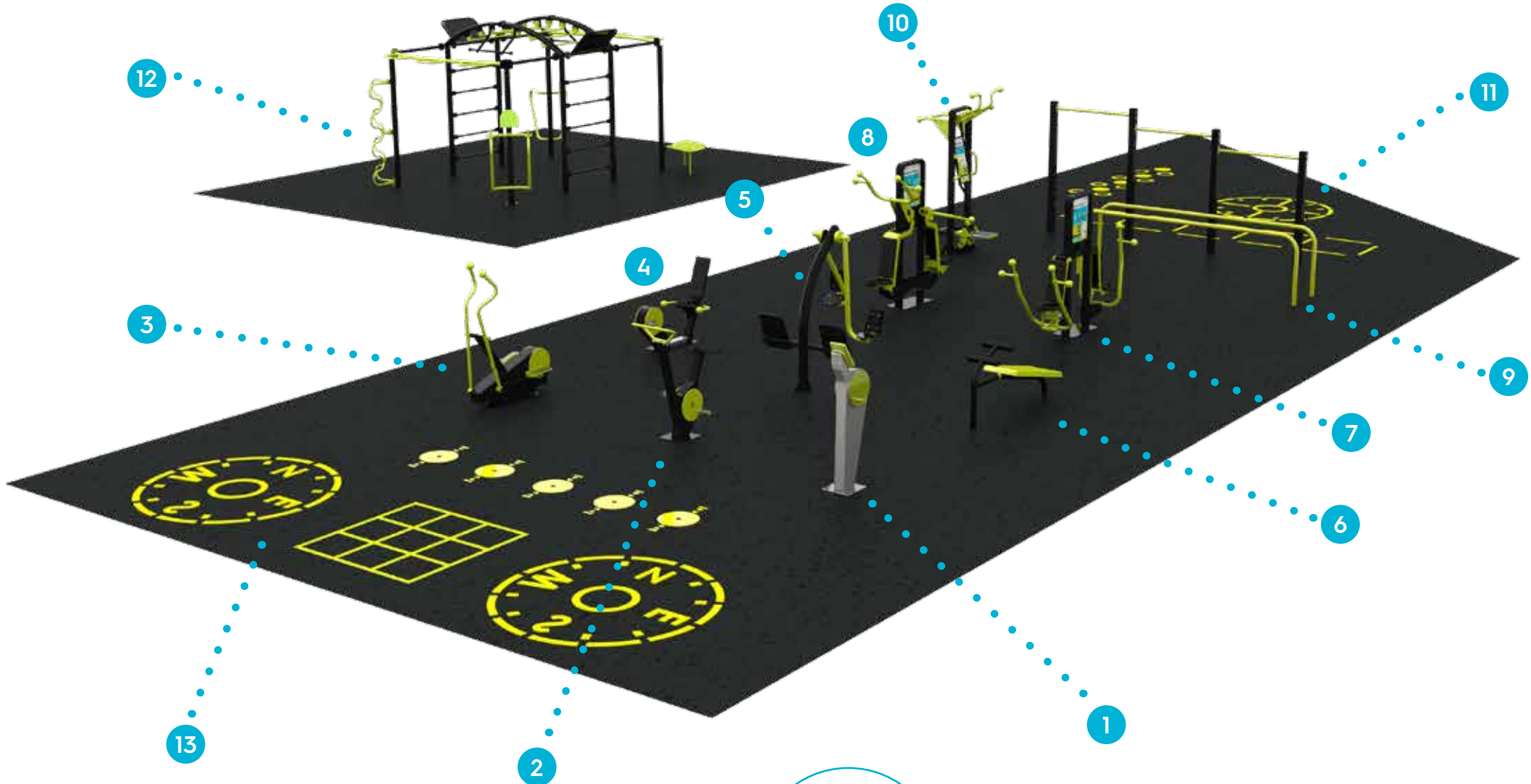

Gym Equipment Limes Farm/Copperfield Estate

1. FS908 Power Smart Hand Bike

Variable Resistance Piece!

The star inclusive piece, it can be used by wheelchair users and able bodied users. An excellent cardiovascular piece of equipment, toning up arms whilst improving muscle, stamina and endurance. All the mechanisms and built in resistance are cleverly concealed within the housing. Charge your device whilst you workout! With the graphics panel you can see your progress with the LED graphs.



2. FS970 Spinning Bike

The spinning bike is a classic machine for any gym. This cardiovascular piece of equipment works the lower body as well as the heart and lungs. All the mechanisms and built in resistance are cleverly concealed within the housing. This makes the spinning bike extremely safe as well as protected from the elements, leaving it smooth and ready to be used by anyone, whatever their starting point.



3. FS861 Cross Trainer

On this stylish cross trainer, the user will get a cardiovascular workout, as well as helping to improve muscle tone in the legs, arms and core. With top quality bearings and sliding mechanisms the TGO cross trainer is smooth, safe and easy to use. From super fit to those new to exercise, this is the perfect piece for any gym. Over the years this has proven to be one of our most popular pieces.



4. FS891 Recumbent Bike

Designed to give the user a cardiovascular workout and improve leg strength and muscle tone. The Recumbent Bike is ideal as a rehabilitation tool and is very popular with older people, keeping the back in a fixed position whilst working the lower body. The Recumbent Bike comes with our bespoke made, all aluminium pedals. These look and work brilliantly, but most importantly, they will never rust.



5. FS040 Double Leg

Using your body weight as the resistance create a great leg workout.



6. FS100 Single Sit Up

The Bench has a number of exercise variations on this piece of equipment not just limited to sit ups. The bench also enables the user to perform incline press ups and tricep dips and the bench caters for a wide variety of sit up and abdominal crunch exercises.



7. FS835 Chest Press/Seated Row

Another star of the TGO range. This upper body double station gives users a fantastic workout as well as saving space, giving two exercises for the price of one, this is a really popular piece. Based on lifting approximately 30% of your body weight, this machine works the chest, arms, shoulders and back (middle to lower) giving a great upper body workout for all abilities.



8. FS825 Lat Pull Down/Shoulder Press

The lat pull down and shoulder press forms the centre piece of many TGO gyms. Based on lifting approximately 30% of your body weight, this machine works the chest, arms, shoulders and back (upper to middle) giving a great upper body workout for all abilities.



9. FS107 Parallel Bars

Works opposing muscle groups while lifting / lowering. Ideal for building core strength, joint flexibility and balance. works all upper body muscle groups and is also a fun engaging piece for all the family.



10. FS810 Pull Up/Assisted Pull Up

Pull Ups have been a core exercise for many years. However many people do not have strength to complete the movement. This station caters for those that can (Pull Up) and those that are aiming to get to that point (Assisted Pull Up).TGO's unique Assisted Pull Up. By stepping on the platform of TGO's unique Assisted Pull Up, the users' own body weight is counter-levered to enable them to perform the equivalent of a 50% pull up.



11. FS503 Triple Pull Up Bar

Targets multiple muscle groups such as back and bicep muscles, and can improve posture. A compound exercise, therefore improving functional strength. Also great for an after workout stretch.

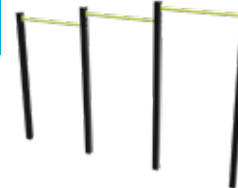

12. TGO510 Calisthenics Rig

The rig is a great piece to target all areas of your body! The gym caters for all abilities whether your super fit or new to exercise. An advantage of having a rig is you are able to attach TRX bands and punch bags to make that workout even more challenging.



Gym Equipment Limes Farm/Copperfield Estate

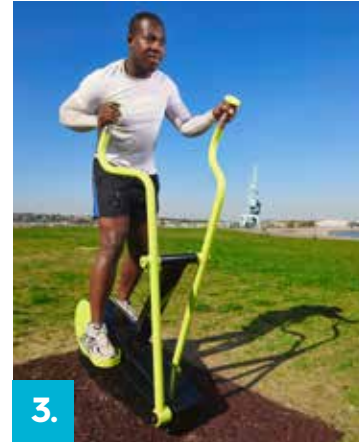
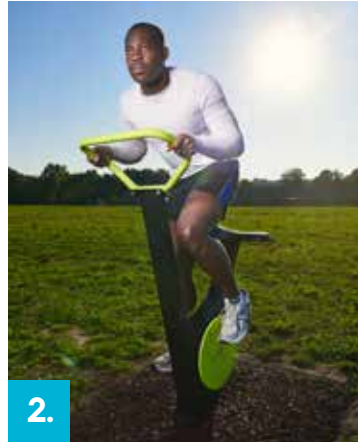

What is Power Smart?



Generates energy



Gives RPM feedback

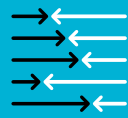

Adjustable resistance



Power output up to 200watts/hr

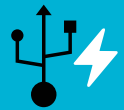

USB device charging 5V



Contactless phone charging

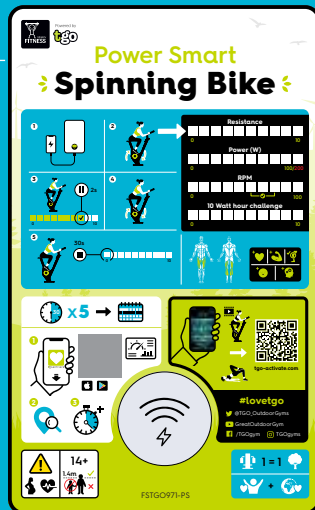

Power Smart Hand Bike

+ Features

- ✓ Accessible to a wide variety of heights and wheelchair users
- ✓ Variable resistance on power smart
- ✓ Contactless phone charging and USB input
- ✓ RPM feedback
- ✓ Power feedback
- ✓ Antimicrobial paint
- ✓ Smart - counts hits

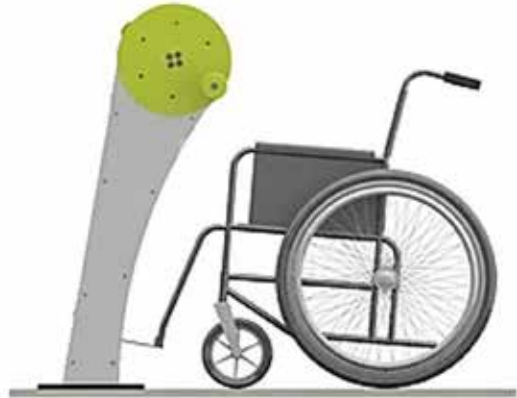

Upgrade your Gym Smart Activator Screen

.....

The Great Outdoor Gym Company (TGO) is introducing another world first in its sector – Smart activator screens. These free classes delivered at TGO gyms on smart screens are community friendly and compliment the gym and park space. The solution offers communities the ability to access a wide range of classes, multiple times a day. The wider access brings the group size down making the solution safer for everyone. Every class has options off the gym so that all TGO gyms work with the smart screen.



Upgrade your Gym Smart Activator Screen

Benefits

- At least 20 classes per day, choose from 7300 classes a year
- Hassle free way of delivering community-wide activation safely
- Catering for up to 70,000 unique visitors per year
- Catering for around 200 people a day
- Brings the gym to life
- Helps people understand what to do when at the gym
- 12 hours of free content per day

TGO gym classes activating your park

- Multiple classes allowing for smaller socially distanced groups
- Workouts include HIIT, yoga, Physio and family workouts
- Every class comes with a warm up and a cool down and a PARQ
- Delivers key messaging about the benefits of physical activity
- Multi-screen layouts to provide circuits in case one station is busy
- Optional sound available
- 10 trees are planted for each one of installed

Specification and Features

- Multi award winning high quality screen and smart city kiosk.
- Portrait screen for maximum visibility of trainer
- Seamless updates of digital content via 4G
- Wind tested up to 140 mph
- Tested to IP56 standards to provide protection from water and dust,
- Sleek and stylish, yet rugged enough to be installed in any application
- Protects electronic components with filters and cooling fans
- Display's Operating Temperature Range: -22°F to 122°F (-30°C to 50°C)
- Supported internationally
- All weather rated
- Professional screen
- High brightness
- Rs232 capability to switch off at night
- Circa 500 w consumption day and 0.5watts at night.
- Smart screen, Includes 55" Xtreme™ High Bright Outdoor Display



Why choose a TGO gym?



Designed by
health and fitness
professionals



Made in
Britain



Safer



Inclusive



Generates
electricity and
it's even Smart

What sets TGO apart

.....

- ✓ TGO gyms are safer
- ✓ TGO gyms are stronger
- ✓ TGO gyms are more sustainable
- ✓ TGO gyms are smarter
- ✓ TGO gyms are more inclusive market
- ✓ TGO gyms are more family friendly
- ✓ TGO gyms are activation friendlier
- ✓ TGO gyms cater for all fitness abilities
- ✓ TGO gyms come with the most experience
- ✓ TGO gyms are the best value on the market



Your gym is Made in Britain

- ✓ 25 year warranty on structural steel
- ✓ Installed worldwide
- ✓ Load and cyclical testing
- ✓ TGO fixings are anti-vandal and anti-tamper
- ✓ CE marked steel
- ✓ Welds certified to BSEN ISO 15614
- ✓ Built-in resistance to offer great health outcomes



Spinning Bikes in production



Hand Bike in production



TGO Manufacturing process

.....



1. All TGO equipment is manufactured in our UK factories (one in Gateshead and one in Selby)



2. UK Sourced Materials – 99% of our component part materials is sourced within the UK meaning we have tighter control over our production and supply. Raw materials and parts are bulk ordered with high re-order levels to ensure we are never without stock of materials & parts.



3. Parts Fabrication – we are continually making batches of component parts for our products. Once an order is received it is added to the Production Schedule for parts to be picked and sent to the Paint Shop.



4. Painting Process – all parts are primed and powder coated in house through our paint plant.



5. Assembly – once parts are painted they are assembled to build the products in our Assembly area.



6. Quality Control – at all stages of the manufacture parts are quality checked. The products received a final quality check before they are palletised & wrapped ready for dispatch.

Your TGO gym is Smart

- ✓ 'Activate' App enables users to find their TGO gym, log and track workouts and share with friends on social media
- ✓ 'Smart' technology in TGO gyms measures hits of gyms
- ✓ 'Smart' gyms come with dashboards for gym owners to measure, engage and sustain usage
- ✓ 'Smart' signage - QR codes on signage to log and track workouts
- ✓ Device holder - to place your device where you can see it charge on cardio charge range



All the signage have two QR codes: 1 QR code allows you to log your workout in the Activate App and 1 QR code shows you where you are able to see a video tutorial on that particular piece.



Your gym is Inclusive

.....

Every piece has been carefully designed with inclusivity in mind featuring key elements of the IFI standards:

- ✓ Large font on signage
- ✓ Wider seats and transfer handles
- ✓ Brightly coloured interactive parts
- ✓ Start and finish diagrams
- ✓ Created for communities - with everyone in mind
- ✓ 'Smart' Hand Bike is featured in most packages
- ✓ TGO Rig features a variety of bars for additional accessories to be added on, such as tricep and bicep bands

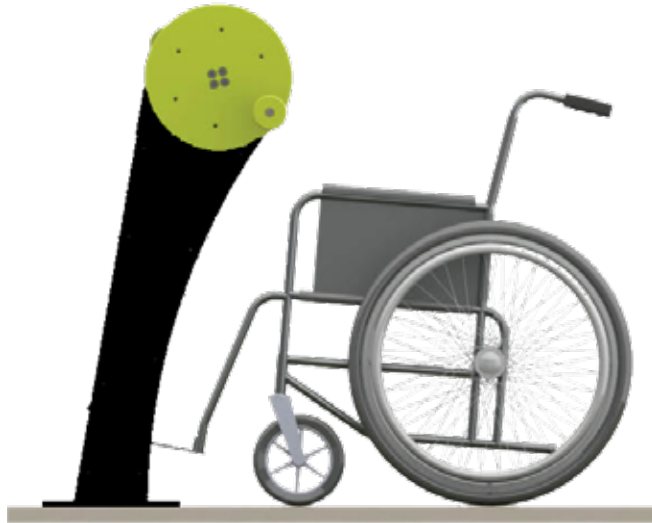

Wheelchair access

Transfer handles

To enable people with mobility problems to access equipment safely

Signage

Start and finish diagrams and large font on signage
Wider seats to give more comfort to the user

Resistance gauged to user's own body weight

This helps to ensure that resistance of equipment (such as the leg press and lat pull down) are not too strenuous, meaning people of all abilities can still participate.



Wider seats and transfer handles on the Lat Pull Down/Shoulder Press

Your gym is Sustainable

.....

- ✓ We recycle human energy with our energy range!
- ✓ We plant a tree for every piece we install in the UK
- ✓ TGO Cardio Charge products charge up smart phones and other devices via USB port (don't forget your USB lead!)
- ✓ Unique console on every TGO Cardio Charge piece. Includes watt counter that lights up in use for motivational boost and wow factor
- ✓ No need to disturb the groundwork if you want to upgrade as we have designed special bases
- ✓ TGO gyms are made to last



We plant a tree for every piece we install!

UK only

We're Planting the FOREST
www.nhsforest.org
growing forests for health

Your gym is Safer

- ✔ TGO equipment is compliant with BS EN16630:2015
- ✔ All TGO stop mechanisms are concealed
- ✔ All moving parts are limited in their movement

- ✔ All moving elements are within the framework of the equipment
- ✔ All TGO equipment is free of crush points, entrapment points, shear-points and sharp edges



Certificate of Compliance

Awarded to The Great Outdoor Gym Co. Ltd.
The Old Dairy, Brogdale Farm, Brogdale Road, Faversham, Kent ME13 8XZ UK

Products:

- TGO100 EDU Display Cabinet
- TGO501 Single Pull Up Bar
- TGO502 Double Pull Up Bar
- TGO503 Triple Pull Up Bar
- TGO504 Parallel Bars
- TGO505 Overhead Ladder
- TGO510 Rig
- TGO701 Full Body Multi Gym
- TGO702 Toning Multi Gym
- TGO703 Cardio Multi Gym
- TGO800 Dips/Leg Raise
- TGO810 Pull Ups/Assisted Pull Ups
- TGO825 Lat Pull Down/Shoulder Press
- TGO835 Chest Press/Seated Row
- TGO841 Plyometric Boxes (range)
- TGO850 Bench
- TGO861/TGO862 Cross Trainer
- TGO870 Leg Press
- TGO888 Sign Frame
- TGO889 Welcome Sign Post
- TGO891/TGO892 Recumbent Bike
- TGO905 Triple Step Up
- TGO907/TGO908 Hand Bike
- TGO941 Treadmill/Oblique
- TGO951 Leg Press/Bench
- TGO970/TGO971 Spinning Bike

Has been tested in accordance with EN16630:2015 limited to the items described above

Drawing pack revision tested: Multiple
Drawing pack date: 05/01/2015 - 10/12/2017
Dates of compliance testing: 08/06-12/06/2015 & 19/12/2017

Valid period 3 years unless the design is revised
Nature of this claim is independent verification

Compliance and testing of permanently installed outdoor fitness equipment manufactured by The Great Outdoor Gym Co. Ltd. in accordance with EN16630:2015, Play-IT declared (full testing reports available upon request)

Mr N A Ford
2 The Avenue, Romford, Essex. RM1 4LD
+44(0)777 1617 239

Certificate of Compliance

Awarded to The Great Outdoor Gym Co. Ltd.
The Old Dairy, Brogdale Farm, Brogdale Road, Faversham, Kent ME13 8XZ UK

Products:

- TGO511 Shortened Rig
- TGO512 Lower Overhead Ladder
- TGO516 Lower Double Pull Up Bar
- TGO517 Lower Parallel Bars
- TGO871 Shortened Leg Press
- TGO887 Activity Generator Sign
- TGO894/TGO898 Shortened Recumbent Bike
- TGO905 Triple Step Up
- TGO911/TGO912 Shortened Hand Bike
- TGO942 Mini Treadmill/Oblique
- TGO860M Mini Cross Trainer

Has been tested in accordance with PAS888:2013 limited to the items described above

Statement: The above products (except TGO905) fall outside of the Scope of EN16630:2015 which specifically excludes equipment designed for users < 1,400mm high. Although superseded by EN16630:2015 PAS888:2013 is the only published National Specification that has a Scope (provided by SW/136 [CEN Standards Committee]) that incorporates Outdoor Fitness Equipment accessible by young people and children. EN16630:2015 should be applied for layout, installation, maintenance and inspections.

Drawing pack revision tested: Multiple
Drawing pack date: 05/01/2015 - 10/12/2017
Dates of compliance testing: 08/06-12/06/2015 & 19/12/2017

Valid period 3 years unless the design is revised
Nature of this claim is independent verification

Compliance and testing of permanently installed outdoor fitness equipment manufactured by The Great Outdoor Gym Co. Ltd. in accordance with PAS888:2013, Play-IT declared (full testing reports available upon request)

Mr N A Ford
2 The Avenue, Romford, Essex. RM1 4LD
+44(0)777 1617 239

CERTIFICATE

No. Z2 090265 0005 Rev. 00

Holder of Certificate: The Great Outdoor Gym Company Ltd.
2 Jubilee Way
Faversham, Kent ME13 8SD
UNITED KINGDOM

Certification Mark:

Product: Fitness Equipment

The product was tested on a voluntary basis and complies with the essential requirements. The certification mark shown above can be affixed on the product. It is not permitted to alter the certification mark in any way. In addition, the certification holder must not transfer the certificate to third parties. This certificate is valid until the listed date, unless it is cancelled earlier. All applicable requirements of the testing and certification regulations of TUV SUD Group have to be complied. For details see: www.tuvstd.com/pe-001

Test report no.: 713211088
Valid until: 2026-09-07

DATE: 2021-10-01

(Michael Weber)

ZERTIFIKAT • CERTIFICATE • CERTIFICADO • CERTIFICAT

Page 1 of 2
TUV SUD Produkt Service GmbH • Certification Body • Notenstraße 66 • 80339 Munich • Germany

Your gym is Stronger

.....

We pride ourselves on our quality. We moved our manufacturing back to the UK in 2012 to control the quality, ensure the materials are to spec and ensure the workmanship is to British standards across the TGO range. This gives us a confidence to offer the following warranty:

- ✓ **25 warranty on metalwork**
- ✓ **5 year warranty on paintwork**
- ✓ **2 year warranty on bearings**

- Made in the UK
- Load and cyclical Testing
- TGO fixings are anti vandal and anti-tamper
- CE marked steel
- Welds certified to BSEN ISO 15614
- All TGO Equipment is E-Coated same technique as car industry

 **MADE IN
BRITAIN**

**We're
Stronger**



TGO maintenance and spare parts

Maintenance requirements

The TGO product range has been designed to require very little maintenance to keep it running smoothly and looking great. However, as many of the pieces have moving parts these will need light maintenance

To keep everything operating as they should this involves some basic daily/weekly/monthly inspections of the equipment, for example, checks for any vandalism or faults, lubrication of moving parts, touching up of any paintwork damage.

We provide you with a 'Light Maintenance Kit' which includes a maintenance manual, correct fixing tools, lubrication oil and touch up paints.

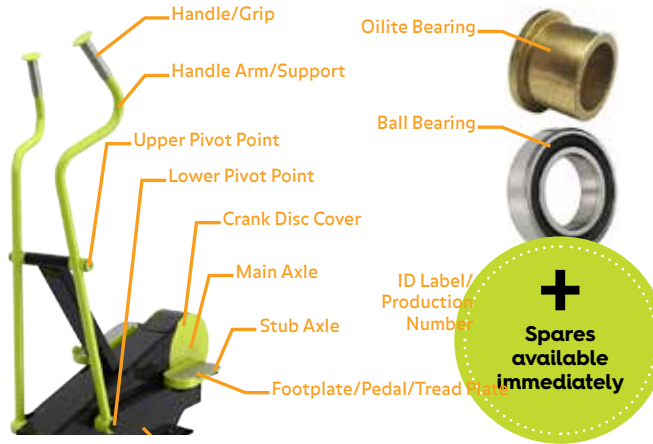

Spares / replacements

TGO can offer an extensive maintenance pack on substantial orders so that spares that may be required are available from that pack immediately (this will include touch up paint, spare fixtures and fittings, bearings etc). Anything from that pack that is used within the warranty period will be replaced FOC (all our stock and spare parts are all made in the UK so lead time is short and no long shipment delays!)

We will keep a record of the detailed specification of your equipment to ensure the spares for your equipment are available for the duration of the contract.

The benefit of TGO with spares/replacements:

1. We manufacture here in the UK
2. Many of our parts are common to each piece
3. Lead time on common spares will be in most cases under 72 hours if not less.

Spares Kits	Per Product	Partner Pack
Cross Trainer	<ul style="list-style-type: none"> 4x MS Cage Nut - For Clad 1x Handle Ring - Rear End 2x M8x16 Pinhead Torx CSNYK - Clads 2x M8x20 Pinhead Torx CSNYK - End caps 2x M8x20 Pinhead Hex Underplate CSNYK - Central fix 1x M8x16 Pinhead Torx Button - Rear Clad 1x MS Washer - Rear Clad 	<ul style="list-style-type: none"> 2x Drive - 117_181_19 FDB - Rear Plank/Handle Pivot 1x Drive - 164M-25-142 1x End Cap - TGOGC3-A-03-05 1x Fitness Plate - TGOGC23-11
Hand Bike	<ul style="list-style-type: none"> 1x M8x20 Pinhead Torx CSNYK - Pedal end cap 2x M8x16 - Clads 1x M8x16 Pinhead Torx Button Head - Top clad 2x M8x20 Pinhead Torx CSNYK - Clads 2x M8x20 Pinhead Hex CSNYK - Central fix 	<ul style="list-style-type: none"> 1x Handle Asm - TGOGC87-A-03 1x Handle End Cap - TGOGC87-01 1x Fitness Plate - TGOGC23-11
Spinning Bike	<ul style="list-style-type: none"> 1x M8x20 Pinhead Torx CSNYK - Pedal end cap 1x M8x16 Pinhead Torx Button Head - Top clad 2x M8x16 Pinhead Torx CSNYK - Clads 2x M8x20 Pinhead Hex CSNYK - Central fix 	<ul style="list-style-type: none"> 1x Pedal Asm - TGOGC07-017 1x End Cap - TGOGC88-06 1x Fitness Plate - TGOGC23-11
Recumbent Bike	<ul style="list-style-type: none"> 1x M8x20 Pinhead Torx CSNYK - Pedal end cap 2x M8x16 - Clads 1x M8x16 Pinhead Torx Button Head - Top clad 2x M8x20 Pinhead Torx CSNYK - Clads 2x M8x20 Pinhead Hex CSNYK - Central fix 	<ul style="list-style-type: none"> 1x Pedal Asm - TGOGC07-017 1x Handle End Cap - TGOGC88-06 1x Fitness Plate - TGOGC23-11
Module	Per Product	Partner Pack
	N/A	<ul style="list-style-type: none"> 2x Central Bearing Housing Assembly 1x Brake Asm - TGOGC88-A-04
Phyometric Box	Per Product	Partner Pack
	N/A	N/A
Leg Press	Per Product	Partner Pack
	<ul style="list-style-type: none"> 2x M8x16 Pinhead Torx CSNYK - Stops 2x M8x20 Pinhead Torx CSNYK - Stops 2x M8x25 Pinhead Torx Button - Track Asm 2x M8x20 Pinhead Torx CSNYK - Wheels 	<ul style="list-style-type: none"> 1x Track Wheel - 251496 POTH 75_15R 1x Bump Stop
Treadmill	Per Product	Partner Pack
	N/A	<ul style="list-style-type: none"> 1x Roller Asm - TGOGC84-A-04
Step Up	Per Product	Partner Pack
	N/A	N/A
Oblique	Per Product	Partner Pack
	<ul style="list-style-type: none"> 2x MS CSK Security Screw (A2) 2x MS Washer (A2) 	<ul style="list-style-type: none"> 2x Drive - 856d50d832 (Top Nut) 1x Drive - 856d50d835 (Plain)
Bench	Per Product	Partner Pack
	<ul style="list-style-type: none"> 2x M8x25 Button Security Screw (A2) 2x MS Washers (A2) 	N/A
Dip and Leg Raise	Per Product	Partner Pack
	<ul style="list-style-type: none"> 2x M8x25 Button Security Screw (A2) 2x MS Washers (A2) 1x M8x16 Button Security Screw (A2) 1x MS Washer (A2) 	<ul style="list-style-type: none"> 2x Signage
Ski Machine	Per Product	Partner Pack
	<ul style="list-style-type: none"> 1x TGOGC72-01 2x M8x20 Security Button security screw (A2) 1x M8x20 Security CSK screw (A2) 1x MS Washer (A2) 1x MS Nylon 	<ul style="list-style-type: none"> 1x Small End Cap - TGOGC72-01 1x Large End Cap - TGOGC83-A-05 1x Pin/Fab - TGOGC83-A-05
CP/R	Per Product	Partner Pack
	<ul style="list-style-type: none"> 2x M8x25 Button Security (A2) - Seats & Backs 	<ul style="list-style-type: none"> 1x End Cap - TGOGC72-01

Energy Recumbent Bike TGO892

It may be necessary at some stage to maintain and access the Parasect board on the USB. The Parasect is the electrical heart of the Cardio Charge (Glow and Flow) Recumbent Bike and is what manages the electricity produced from the equipment. This should rarely need visiting, but in the event it does, TGOGC have provided some basic instructions (below) on how to access it.

The USB is what TGOGC call a consumable item and therefore not warranted by TGO. However, it is a low cost product and is simple to replace.

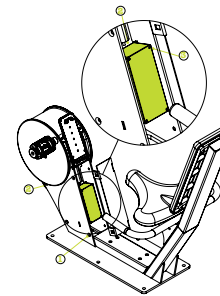

- 1 Remove the four (4) M6 CSK Pin Torx Screws from the side of the pedal support, to release the rear clad. Place this clad and flange to one side.
- 2 The Parasect will be bolted in a vertically standing position as shown in the diagram. To remove the parasect fully you will need to unscrew the two (2) M6 flange screws from the rear of the Parasect box.
- 3 In order to access the electronics, the Parasect box lid must be removed, by unscrewing all four (4) M6 CSK Pin Torx screws and two (2) M6 CSK Pin Torx screws that hold the top of the lid.
- 4 In order to access the electronics, the Parasect box lid must be removed, by unscrewing all four (4) M6 CSK Pin Torx screws and two (2) M6 CSK Pin Torx screws that hold the top of the lid.

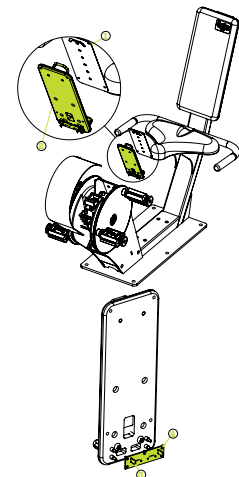

- 1 Remove the stainless steel graphic plate from the console. Via the four (4) M6 Button Pin Torx screws. Retain the screws and put the graphics plate to one side.
- 2 Remove the four (4) now exposed M6x20 CSK Pin Torx Screws which hold the console to the cross trainer frame. Retain the flange in a safe place.
- 3 To remove the USB, unplug the two quad connector ports. Remove the four (4) M6 Nuts and washers, and slide the USB board off the M6 inserts.
- 4 Reapply the new USB board and reverse the above steps to reapply the console.

NOTE 1: Take care as to not damage the casing as the console is pulled away from the cross trainer.

NOTE 2: Take care as to not damage the casing as the console is pulled away from the cross trainer.

NOTE 3: The lid screws should be torqued to 5-18N/m in order to retain the IP rating.

4 Reverse Procedure to reassemble.



TGO aftersales service

.....

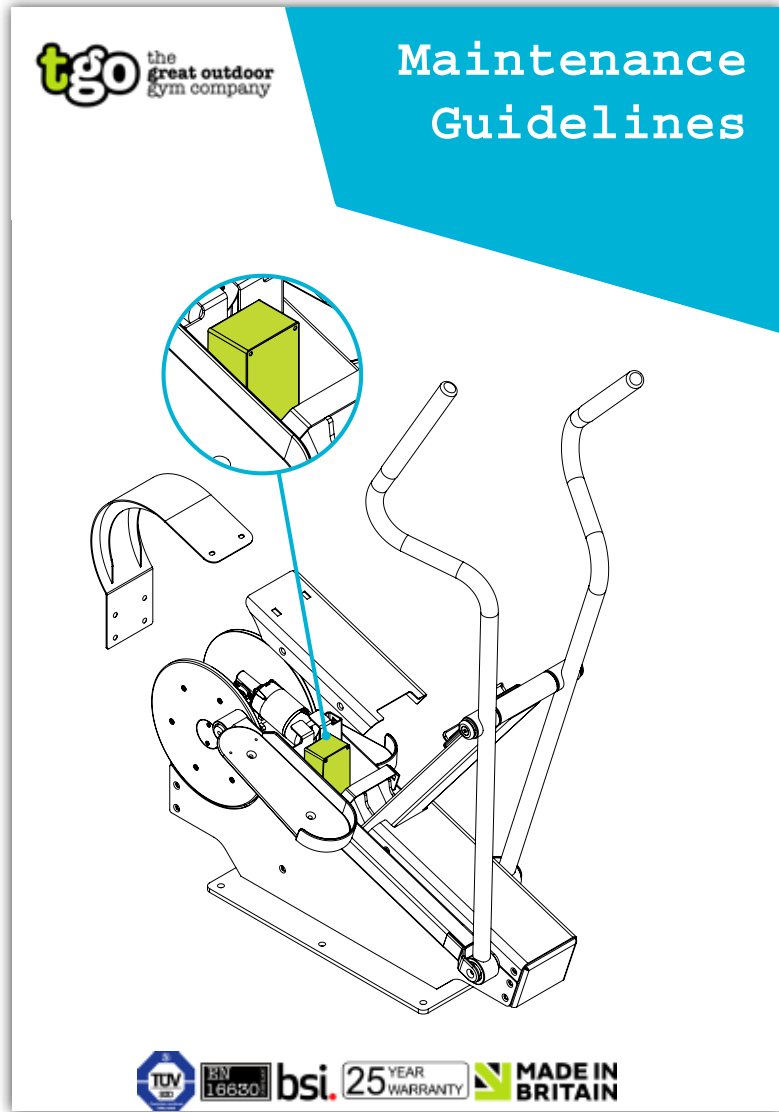

Maintenance

TGO has been ploughing care into its designs over the past 8 years, ever improving its offer and eradicating known issues. TGO is always aiming for a maintenance free product. However it is important to care for your new gym to ensure it stays in good and safe working order.

TGO is prepared to wrap in maintenance if a number of gyms are purchased.....

Our promise for your gym aftercare

- Provide you with all the necessary tools to keep your gym in great condition
- Provide you with support and training
- Ensure all consumable elements are available to you in under 72 hours
- Provide you with great warranties
- If a part should break under warranty we will supply a replacement or a fix without any quarms within 4 weeks





FREE!
tgo

JOIN THE *Movement*
JOIN THE BIG COMMUNITY WORKOUT HERE EVERY SATURDAY

DOWNLOAD • REGISTER • ACTIVATE • BE EMPOWERED

FOR EVERYONE ALL AGES & ABILITIES IT'S FREE BRING A FRIEND RECLAIM YOUR HEALTH IT'S NEVER TOO LATE TO START

TGOGC TGOGyms @TGO_Outdoor Cyms

tgo
ACTIVATE

Thank you for taking the time to read through this document.

We do hope that you choose British design, innovation and manufacturing.

Sustainable Wellness

Activate your community

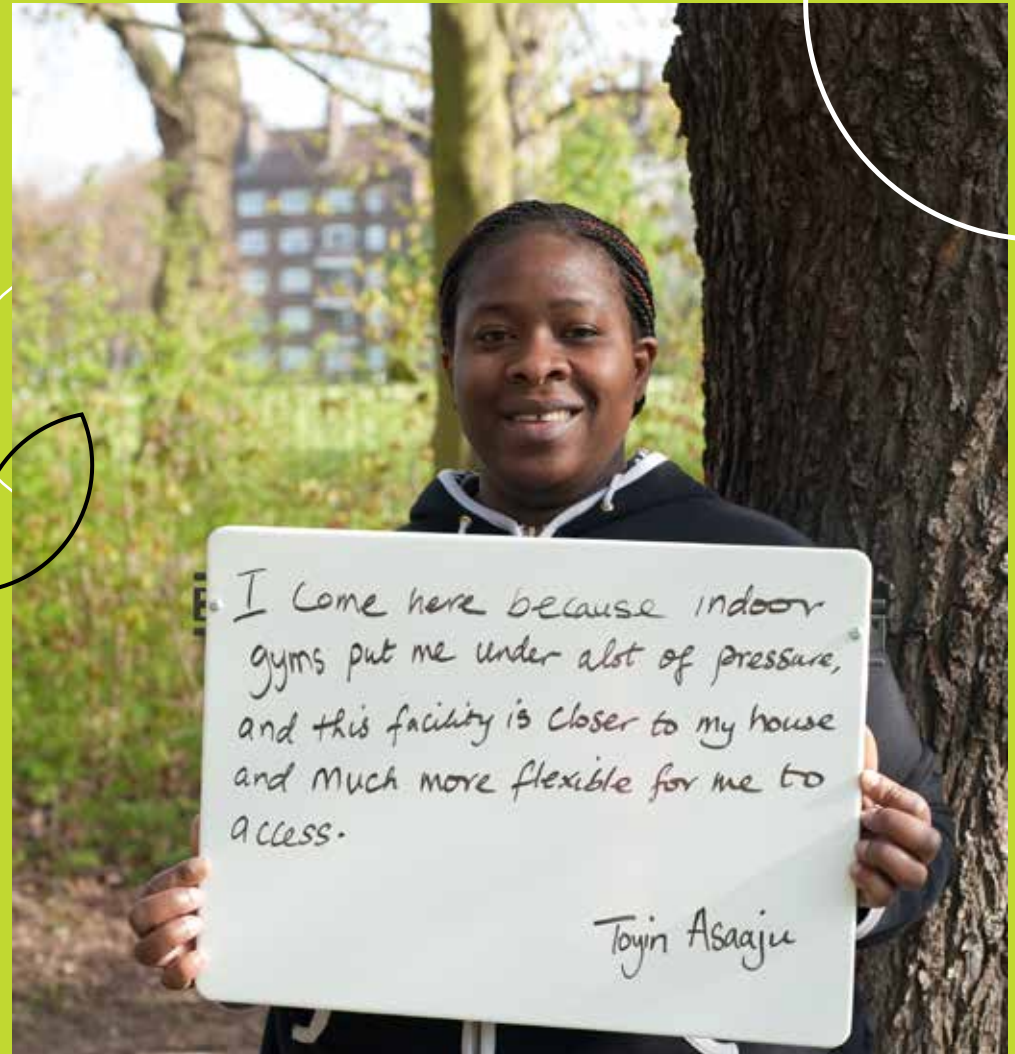

1. DEFINITIONS

Business Day: A day (other than a Saturday Sunday or Public Holiday) when banks in London are open for business.

Conditions: The Terms & Conditions set out in this document as amended from time to time.

TGO: The Great Outdoor Gym Company Ltd registered in England and Wales with Company Number: 6041524.

Contract: The Contract between TGO and the Customer for the sale and purchase of the goods or the sale and purchase and installation of the goods in accordance with these Conditions.

Customer: The person, firm, corporate body or public sector authority who purchases the goods from TGO.

Force Majeure Event: An event of circumstance beyond the party's reasonable control.

Goods: The Goods (or any part of them) set out in the order.

Order: The Customer's Order for the Goods as set out in the Customer's purchase order form or the Customer's written acceptance of TGO's quotation.

Specifications: Any Specification for the Goods including any related plans and drawings provided by TGO.

2. INTERPRETATION

(a) A reference to a statute or statutory provision is a reference to such statute or provision as amended or re-enacted. A reference to a statute or statutory provision includes any subordinate legislation made under that statute or statutory provision as amended or re-enacted.

(b) Any phrase introduced by the terms including, include, in particular or any similar expression shall be construed as illustrative and shall not limit the sense of the words preceding those terms.

(c) A reference to writing, written or includes emails.

3. BASIS OF CONTRACT

3.1 These conditions apply to the Contract to the exclusion of any other terms that the Customer seeks to impose or incorporate, or which are implied by trade, custom, practice or course of dealing.

3.2 The Order constitutes an offer by the Customer to purchase the Goods in accordance with these Conditions. The Customer is responsible for ensuring that the terms of the Order are complete and accurate.

3.3 The Order shall only be deemed to be accepted when TGO issues an acknowledgement of order at which point the Contract shall come into existence.

3.4 The Customer waives any right it might otherwise have to rely upon any terms endorsed upon, delivered with or contained in any documents of the Customer that is inconsistent with these Conditions.

3.5 Any samples, drawings, descriptive matter or advertising produced by TGO and any descriptions or illustrations contained in TGO's catalogues or brochures are produced for the sole purpose of giving an approximate idea of the goods referred to in them. They shall not form part of the Contract nor have any contractual force.

3.6 A quotation for the Goods given by TGO shall not constitute an offer. A quotation shall only be valid for a period of 20 business days from its date of issue.

4. GOODS

4.1 The Goods are described in TGO's catalogue as modified by any item or change specified in the quotation produced by TGO.

4.2 TGO reserves the right to amend the Specification of the Goods if required by any applicable statutory or regulatory requirements.

5. DELIVERY

5.1 TGO supplies its Goods on an ex works basis. The Customer shall collect the Goods from TGO's manufacturer's premises or such other location as may be advised by TGO prior to collection within 3 business days of TGO notifying the Customer that the Goods are ready.

5.2 Delivery is completed on the completion of loading of the Goods at the collection location.

5.3 Any dates quoted for delivery are approximate only and the time of delivery is not of the essence. TGO shall not be liable for any delay in delivery of the Goods that is caused by a Force Majeure Event or the Customer's failure to provide TGO with any instructions that are relevant to the supply of the Goods.

5.4 If TGO fails to deliver the Goods its liability shall be limited to the costs and expenses incurred by the customer in obtaining replacement Goods of similar description and quality in the cheapest market available, less the price of the Goods. TGO shall have no liability for any failure to deliver the Goods to the extent that such failure is caused by a Force Majeure Event or the Customer's failure to provide TGO with adequate instructions which are relevant to the supply of the Goods.

5.5 If the Customer fails to collect the Goods within 3 business days of TGO notifying the Customer that the Goods are ready, then, except where such failure or delay is caused by a Force Majeure Event or TGO's failure to comply with its obligations under the Contract:

(a) Delivery of the Goods shall be deemed to have been completed at 9.00am on the third business day after the day on which TGO notified the Customer that the Goods were ready; and

(b) TGO shall store the Goods until collection takes place and charge the Customer for all related costs and expenses

5.6 If 15 business days after the day on which TGO notified the Customer that the Goods were ready for collection and the Customer has not made collection of the Goods TGO may resell or otherwise dispose of part or all of the Goods and after deducting reasonable storage and selling costs account to the Customer for any excess over the price of the Goods or charge the Customer for any shortfall below the price of the Goods.

5.7 TGO may deliver the goods by up to 3 instalments which shall be invoiced and paid for separately. Any delay in delivery or defect in an instalment shall not entitle the customer to cancel any other instalment.

5.8 In the event of any of the Goods collected by the Customer being damaged the Customer must report that damage to TGO on the same day as collection.

5.9 In the event of TGO agreeing to deliver the Goods to the Customer and in the event of those Goods being found to be damaged the Customer must report the damage to TGO on the same day as delivery to the Customer.

5.10 If the Customer fails to report damage as required by Clauses 5.8 and 5.9 TGO shall not be liable to the Customer for any loss arising from the damage.

6. QUALITY

6.1 TGO warrants that on delivery and for a period of 12 months from the date of delivery (warranty period) the Goods shall:

(a) Conform in all material respects with their description; and

(b) be free from material defects in design material and workmanship; and

6.2 TGO further warrants components of its Goods:

25 YEAR WARRANTY on the structural integrity of steel posts, all welds, bars and steel structural equipment.

10 YEAR WARRANTY against significant corrosion on galvanised products, which are erected at least 250m from the coastline.

5 YEAR WARRANTY on galvanised products, which are situated within 250m of the coastline.

5 YEAR PAINT WARRANTY for paintwork against material fade from exposure to ultra violet light.

1 YEAR WARRANTY on green energy gym electronics excluding batteries and USB ports.

2 YEAR WARRANTY on bearings and bearing cases.

2 YEAR WARRANTY on plastic or composite parts, seats and fittings and clamps.

1 YEAR WARRANTY on gears.

Rubber handles, USB ports, batteries and polyurethane traveller wheels are not covered by warranty but should be replaced during maintenance if required.

6.3 The warranties given in 6.1 and 6.2 above are made upon the following conditions:

(a) The Warranty begins from the date of dispatch from the TGO warehouse.

(b) Customers must satisfy themselves that they can carry out the maintenance instructions proficiently using adequately trained engineers.

(c) These warranties do not cover installation faults. Customers must satisfy themselves that installations have been carried out in accordance with the installation instructions specified by TGO.

(d) TGO shall replace faulty products by sending the replacement part to a designated warehouse. TGO shall pay for posting and packaging. The customer may be required to return the faulty part within 30 days at their own cost.

(e) The Customer must pay for the labour cost of the maintenance engineer to carry out all works necessary to diagnose, extract the faulty part, leave the site safe and reinstall safely the replacement part.

(f) The Customer shall assess the risk of the site pending repair or during repair to ensure that there is no risk to the health and safety of the general public.

(g) In the event of the Customer or appointed maintenance contractor not carrying out its maintenance obligations as set out in TGO's maintenance instructions published from time to time by TGO on its website or in writing these warranties shall be null and void. TGO shall be entitled to request to see the Customer's maintenance log books from time to time with the names, dates and signatures of engineers.

(h) Non galvanised product must not be situated within 1km of the coast.

(i) The warranties do not cover damage caused by accident, negligence, normal wear and tear, failure to maintain or misuse.

(j) The Customer must report all warranty claims within 14 days. The report to TGO must include correct name of product, installation date, a photo of the manufacturing label, photographic evidence and clear description of issues.

(k) The Customer may assign the benefit of the guarantee to a purchaser of or a successor of title to the gym equipment provided that the Customer sends within 4 weeks of the assignment a copy of the same to TGO plus a fee of £75 plus vat.

(l) TGO shall not be liable for any consequential loss or damage arising from the failure of the equipment other than for loss or damage which arise from personal injury or death for which no limit on liability is placed.

(m) The warranties do not cover consumable items.

6.4 Except as provided in this clause TGO shall have no liability to the Customer in respect of the Goods failure to comply with the warranty set out in Clause 6.1.

6.5 The terms implied by Sections 13 to 15 of the Sale of Goods Act 1979 are, to the fullest extent permitted by law, excluded from the Contract.

6.6 The Conditions shall apply to any repaired or replacements Goods supplied by TGO.

6.7 The TGO Warranties do not apply to branded goods bought in from other manufacturers to fill the customer's order. The liability of TGO in relation to those goods is limited to the warranty provided by those manufacturers.

6.8 No warranty against corrosion is given for any product galvanised or not which is in direct and regular contact with chlorinated water salt water or salt spray.

7. SAFETY

7.1 Customers must ensure that all Goods purchased from TGO are installed by competent workmen using high quality materials and in accordance with Standard EN16630.

7.2 Immediately following the installation of the Goods referred to above the Customer must arrange for the installation to be inspected by a Registered Play Inspector and obtain a certificate that the installation is safe and has been made in accordance with Standard EN16630 and TGO's installation manual.

7.3 In the event of any fault occurring in any of the Goods the Customer shall take out of service to the public the product to which the fault relates until the faulty product has been repaired/replaced.

7.4 TGO shall be entitled to send to the customer product defect warnings and in the event of the Customer receiving any such warning the Customer shall act on the recommendations of TGO incorporated within the product warning so as to ensure that there is no risk of the fault becoming a risk to safety.

7.5 TGO shall be entitled to require the Customer to change the signage relating to any of the Goods and in the event of this right being exercised by TGO the replacement signage shall be provided free of charge.

8. TITLE AND RISK

8.1 The risk in the Goods shall pass to the Customer on collection.

8.2 Title to the Goods shall not pass to the Customer until the earlier of;

(a) TGO receives payment in full for the Goods and

(b) The Customer resells the Goods in which case the title to the Goods shall pass to the Customers immediately before that resale has taken place.

9. PRICE AND PAYMENT

9.1 The price of the Goods shall be the price set out in the Order

9.2 The price of the Goods;

(a) Excludes amounts in respect of Value Added Tax (VAT) which the customer shall additionally be liable to pay to TGO at the prevailing rate, subject to the receipt of a valid VAT invoice and

(b) Excludes the costs and charges of packaging insurance and transport of the Goods.

9.3 The Customer shall pay the invoice in full within 30 days of the date of the invoice. Payment shall be made to the bank account nominated in writing by TGO

9.4 If the Customer fails to make any payment due to TGO under the Contract by the due date for payment then the Customer shall pay interest on the overdue amount at the rate of 10% per annum. Such interest shall accrue on a daily basis from the due date until actual payment of the overdue amount, whether before or after judgement. The Customer shall pay the interest together with the overdue amount.

9.5 The Customer shall pay all amounts due under the contract in full without any set-off, counterclaim, deduction or withholding (except for any deduction or withholding required by law). TGO may at any time without limiting any other rights or remedies it may have, set off any amount owing to it by the customer against any amount payable by TGO to the Customer.

9.6 In the event of the Customer cancelling the order made by the Customer and that cancellation is received by TGO before the Goods have been delivered by TGO to the Customer or collected by the Customer the Customer shall pay to TGO by way of liquidated and ascertained damages 50% of the price of the Goods within 14 days from the date of cancellation.

9.7 In the event of the Customer cancelling the order made by the Customer after the Goods have been delivered by TGO to the Customer or collected by the Customer the Customer shall pay to TGO 100% of the price within 28 days from delivery of the Goods to the Customer or collection of the Goods by the Customer.

10. INSTALLATION

10.1 This entire clause shall only apply to Contracts where TGO has agreed with the customer to install TGO Goods at a site nominated by the Customer.

10.2 In the event that this clause does apply and it then being found that there is a conflict between this clause and other clauses in these Terms and Conditions the provision made under this clause shall prevail.

10.3 The Customer shall obtain prior to commencement of the installation all necessary Consents statutory or otherwise required for the works of installation.

10.4 TGO will execute the works of installation using good and sound materials and in a proper and workmanlike manner.

10.5 The customer shall pay to TGO the price of the Goods and installation 30 days from the date of practical completion.

10.6 TGO shall certify the date of practical completion.

10.7 The risk in the Goods shall vest in the Customer as from the date of practical completion and the Public Liability risk in the installation as a whole shall vest in the Customer as from the date of practical completion.

10.8 The customer warrants that the ground conditions for the intended installation contain no special adverse properties or features. Should it be discovered that the Customer's site does have adverse properties or features TGO's surveyor shall define those adverse properties or features and the cost of overcoming the same so that the installation may proceed.

10.9 TGO will provide the customer with a copy of the report from the surveyor. The Customer will have 10 days in which to accept the report and pay for the additional works, or terminate the Contract by paying 25% of the contract Price in compensation.

10.10 In the event of the Customer electing to terminate the contract pursuant to clause 9.9 above the property in the Goods will remain with TGO and not with the Customer.

11 TERMINATION

11.1 Without limiting its other rights or remedies, TGO may terminate the Contract with immediate effect by giving a written notice to the Customer if:

(a) The Customer commits a material breach of any term of the Contract and (if such a breach is remediable) fails to remedy that breach within 10 Business Days of that party being notified to do so;

(b) The Customer takes any step or action in connection with its entering administration, provisional liquidation or any composition or arrangement with its creditors (other than in relation to a solvent restructuring), being wound up (whether voluntarily or by Order of the Court, unless for the purpose of a solvent restructuring), having a receiver appointed to any of its assets or ceasing to carry on business.

(c) The Customer suspends, threatens to suspend, ceases or threatens to cease to carry on all or a substantial part of its business or

(d) The Customer's financial position deteriorates to such an extent that in TGO's opinion the Customer's capability to adequately fulfil its obligations under the Contract have been placed in jeopardy.

11.2 Without limiting its other rights or remedies, TGO may suspend provision of the Goods under any Contract it may have with the Customer if the Customer becomes subject to any of the events listed in clause 11.1(a) to Clause 11.1(d) or TGO reasonably believes that the Customer is about to become subject to any of them or if the Customer fails to pay any amount due under the contract on the due date for payment.

11.3 On termination of the contract for any reason the Customer shall immediately pay to TGO all of TGO's outstanding unpaid invoices and interest.

12 LIMITATION OF LIABILITY

12.1 nothing in these conditions shall limit or exclude TGO's liability for:

(a) Death or personal injury caused by its negligence or the negligence of its employees, agents or sub-contractors

(b) Fraud or fraudulent misrepresentation.

(c) Breach of the terms implied by Section 12 of the Sale of Goods Act 1979 or

(d) Defective products under the Consumer Protection Act 1987 or

(e) Any matter in respect of which it would be unlawful for TGO to exclude or restrict liability.

12.2 Subject to Clause 11.1:

(a) TGO shall under no circumstances whatsoever be liable to the Customer, whether in Contract, tort (including negligence), breach of statutory duty, or otherwise, for any loss of profit on any indirect or consequential loss arising under or in connection with the Contract and

(b) TGO's total liability to the Customer in respect of all other losses arising under or in connection with the Contract whether in Contract, tort (including negligence), breach of duty, or otherwise, shall in no circumstances exceed 150% of the price of the Goods.

13 FORCE MAJEURE

Neither party shall be in breach of contract nor liable for delay in performing, or failing to perform, any of its obligations under the Contract if such delay of failure result from a Force Majeure Event. If the period of delay or non-performance continues for 13 weeks then either party may terminate the Contract by giving 2 weeks written notice to the other.

14 GENERAL

14.1 Assignment and other dealings.

(a) TGO may at any time assign, transfer, mortgage, charge, sub-contract or deal in any manner with all or any of its rights or obligations under the contract.

(b) The Customer may not assign, transfer, mortgage, charge, sub-contract, declare a trust over or deal in any other manner with any or all of its rights or obligations under the contract without the prior written consent of TGO.

14.2 Entire Agreement.

(a) The Contract constitutes the entire agreement between the parties and supersedes and extinguishes all previous agreements, promises, assurances, warranties, representations and understandings between them, whether written or oral, relating to its subject matter.

(b) Each party agrees that it shall have no remedies in respect of any statement, representation, assurance or warranty (whether made innocently or negligently) that is not set out in this agreement.

14.3 Variations

No variation of the Contract shall be effective unless it is in writing and signed by a director of TGO or an authorised representative of the Customer

14.4 Severance

If any provision or part-provision of the Contract is or becomes invalid, illegal or unenforceable, it shall be deemed modified to the minimum extent necessary to make it valid, legal and enforceable. If such modification is not possible, the relevant provision or part-provision shall be deemed deleted. Any modification to or deletion of a provision or part-provision under this clause shall not affect the validity or enforceability of the rest of the Contract.

14.5 Notices

(a) Any notice or other communication given to a party under or in connection with the Contract shall be in writing addressed to its principle place of business or such other address as that party may have specified to the other in writing in accordance with this clause and shall be delivered personally, sent by pre-paid 1st Class post or other next working day delivery service, commercial courier, or email.

(b) The provisions of this clause shall not apply to the service of any proceedings or other documents in any legal action.

14.6 Third Party Rights

No one other than a party to this Contract and their permitted assignees shall have any right to enforce any of its terms.

14.7 Governing Law

The contract and any dispute or claim arising out of or in connection with it or its subject or formation shall be governed by and construed in accordance with the law of England and Wales.

14.8 Jurisdiction

Each party irrevocably agrees that the Courts of England and Wales shall have exclusive jurisdiction to settle any dispute or claim arising out of or in connection with the Contract or its subject matter or formation.





Thank you

.....

Limes Farm/Copperfield Estate for Baily Garner
Vision Board

.....